

PARTS LIST

Cast Iron Parts

P-301	Base	P-363	Fireback	P-355	Ext. door	1
P-302	Leg	P-364L	Left side fireback retainer	P-356a	Int. upper side (front)	1
P-303	Cast iron cook top	P-364-R	Right side fireback retainer	P-357a	Int. upper side (rear)	1
P-307	Top	P-364-B	Fireback retainer, back edge	P-358	Int. bricks	8
P-309	Back	P-365	Front over glass	P-359	Int. back (middle)	1
P-310	Front	P-366	Front under glass	P-360	Int. under-the-door	1
P-311	Fettle/Andirons	P-367	Left side – non-door style	P-361	Top stone ctr.	1
P-313-R	Right side doorframe	P-368	Left side – door style	P-361L	Top stone left	1
P-313-L	Left side doorframe	P-369	Right side – door style	P-361R	Top stone right	1
P-314	Door	P-370	Right side – non-door style			
P-315	Door stone retainer	P-371	Bypass hold down	Other:		
P-316	Door latch	P-372	Bypass lift guide	K-533-SS	Catalytic combustor	
P-318-A	Bottom fill plate	P-374	Bypass activation shaft	P-807	Inconel screen	
P-319	Ash grate	P-375	Bypass handle	P-2500	EPA Cert label	
P-320	Left air channel	P-376	Rear stone retainer	P-2491	Ash door caution label	
P-321	Right air channel	P-377	Int. Corner stone retainer	P-2472	Tie rod for PH	
P-322	Fireback dome (kettle)	P-378	Top heat shield	P-2802	Pallet for PH	
P-323	Front air manifold/wash	P-379	Primary damper butterfly	P-385E	Window glass	
P-324	Stone retainer – non-door side	P-380	Secondary damper butterfly	P-385E-IR	Int. glass	
P-325	Catalyst base – bypass plate	P-381	Damper control rod			
P-326	Catalyst top	P-386	Damper knob	Ash pan assembly:		
P-327S	Bypass door	P-387	Door ring handle	P-335	Ash pan	
P-329	Fall-Away Handle	K-388	Top stone medallion	P-336	Ash pan cover	
P-330	Corner	P-390	Door handle spacer	P-337	Ash pan holder	
P-331	Flue cover plate	P-391	Cook top handle	P-338	Ash door inner	
P-332	Flue collar			P-339	Ash door outer	
P-333	Escutcheon	Soapstone Parts		P-340	Ash door handle	

Steel/Sheet Metal Parts

W-312	Window clips	P-347	Int. front corner	#pcs	2
P-318B	Bottom Heat Shield, fill plate type	P-348	Int. right rear corner		2
P-334	Damper housing	P-350	Ext. full side		1
P-353P	Stone edge liner	P-351	Ext. over-the-door		1
		P-352a	Ext. over-the-front		1
		P-352b	Ext. under-the-front		1
		P-353	Top stone		1
		P-354	Corner		4

Ash pan assembly:

P-335	Ash pan
P-336	Ash pan cover
P-337	Ash pan holder
P-338	Ash door inner
P-339	Ash door outer
P-340	Ash door handle
P-341	Ash box bottom heat shield

Rear heat shield assembly:

P-384a	Rear heat shield
P-384b	Damper cover
P-384c	Rear flue cover
P-384d	Fall away handle holder

Gasket List

Part #	Desc.	Location	Density
21067	.500MD Round	Firebox Steel Body to W-301 Base	LD1 density
21067 AD	.500 Round, w/ adhesive	W-337 to W-301	LD1 density
21085	.250 Round	W-320, W-321, W-323	LD2 density
21066	.500G Round	Bottom Edge of W-326	LD1 density
21085	.250 Round	Catalytic Combustor seal	LD2 density
21086	.250 Round	Top of W-320, W-321 to Steel Body	LD2 density
21085	.250 Round	W-322 to right Air Channel	LD2 density
21049	.250 Round	W-322 to Left Air Channel	LD1
21050	.187 Round	W-322 to W-309 Back	LD2
21092	.375G Round	W-313 Door Frame to Steel Body	LD2
21063	.500MD Round	W-314 Door to W-313 Frame	LD1 density
21066	.500G Round	W-307 Top to Steel Body	LD1 density
21085	.250 Round	Under W-353, Stone Top	LD2 density
21158	.500G Round	W-338 Ash door inside	LD1 density
21085	.250 Round	W-331 Flue Cover Plate	LD2 density
21085	.250 Round	W-332 Flue Collar	LD2 density

REAR HEAT SHIELD DIAGRAM

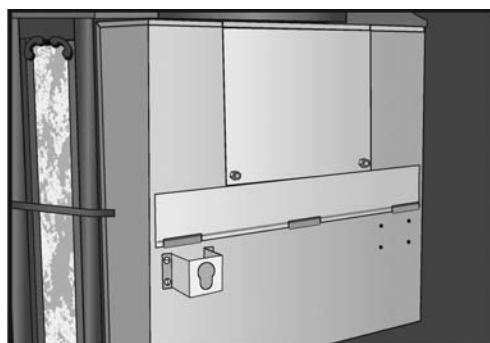
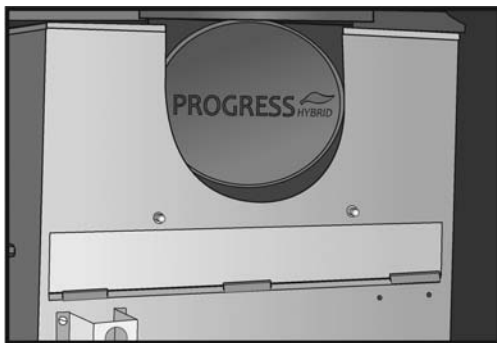
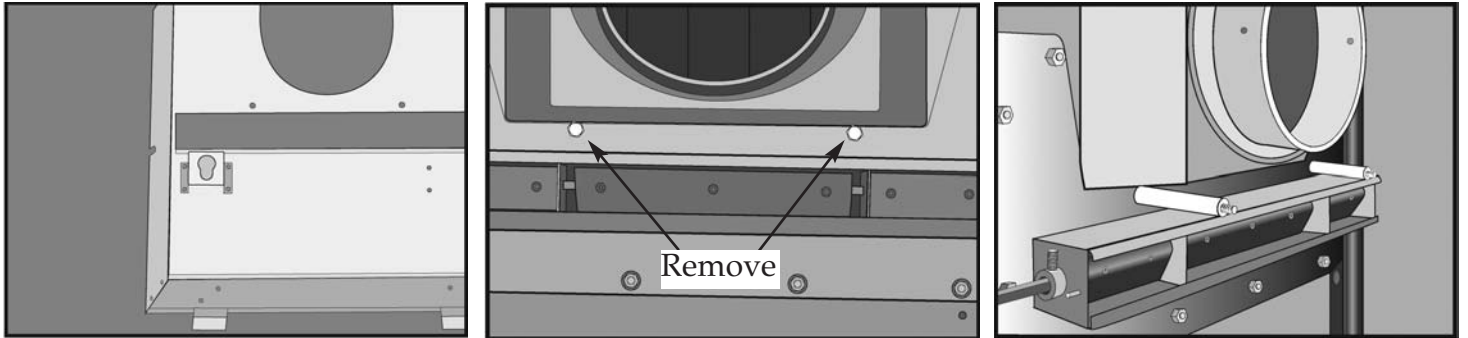
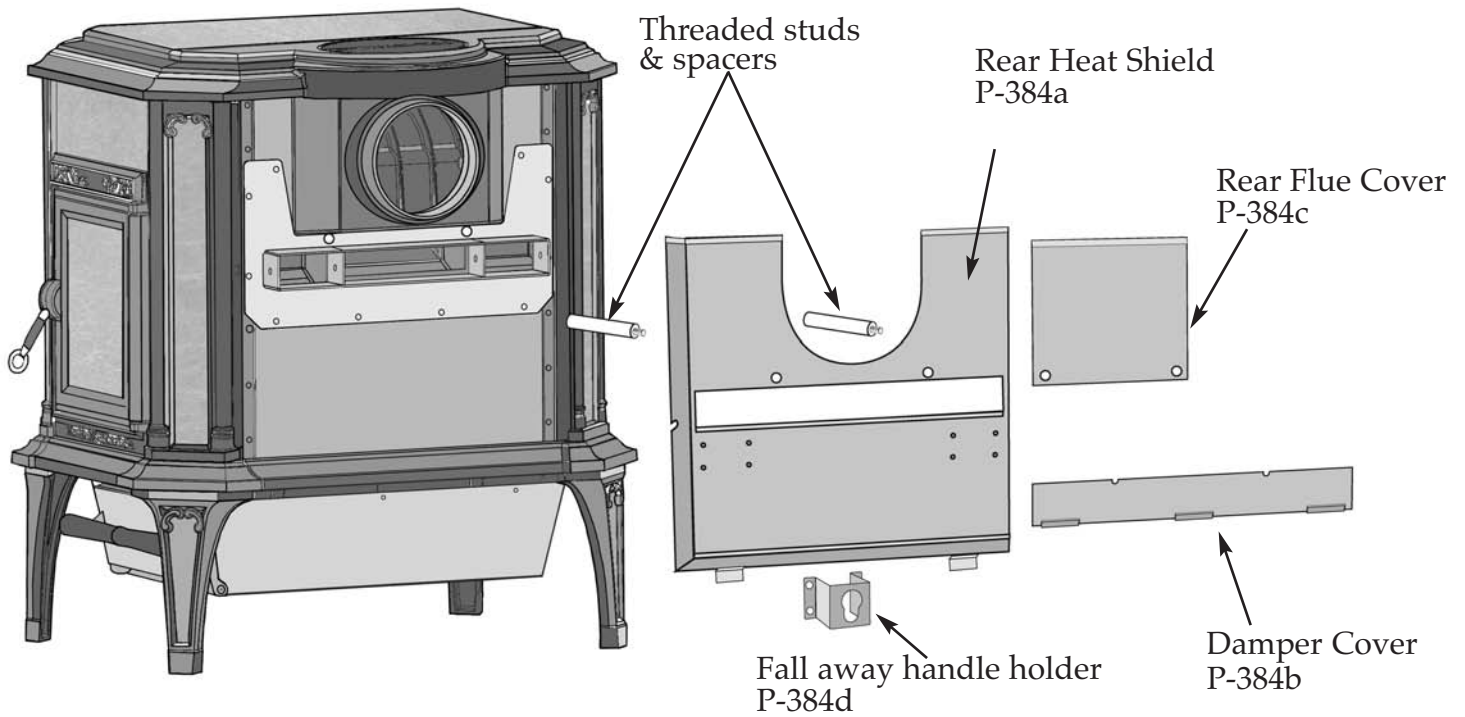

Detailed installation instructions are included with the rear heat shield kit. If you have any installation questions, please call us toll free at 1-800-866-4344

BOTTOM HEAT SHIELD DIAGRAM

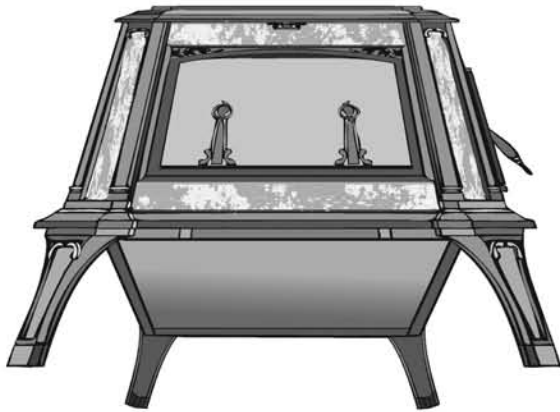

NOTE: The fill plate must be installed inside the firebox before the bottom heat shields are attached.



Bottom fill plate
P-318

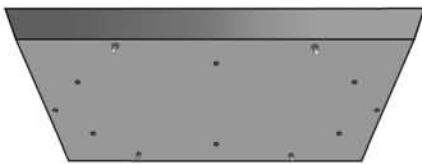

Shield #1
P-318b

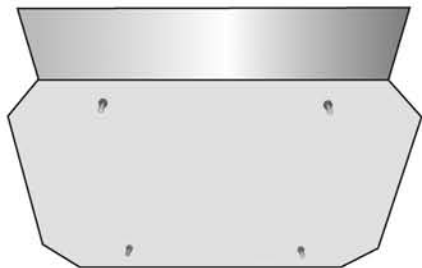
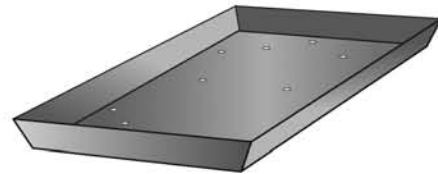

Shield #2
P-318c

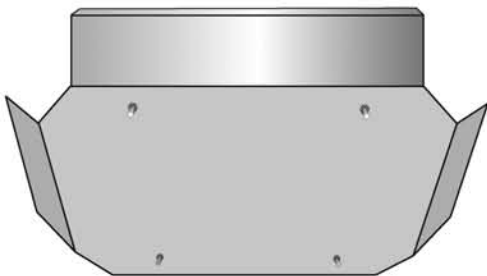

Shield #3
P-318d

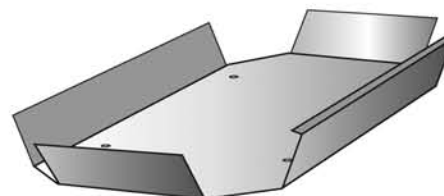

Detailed instructions and hardware are included with the bottom heat shield kit. If you have any installation questions, please call us toll free at 1-800-866-4344

ASH PAN DIAGRAM

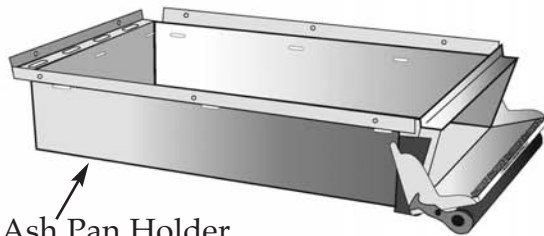
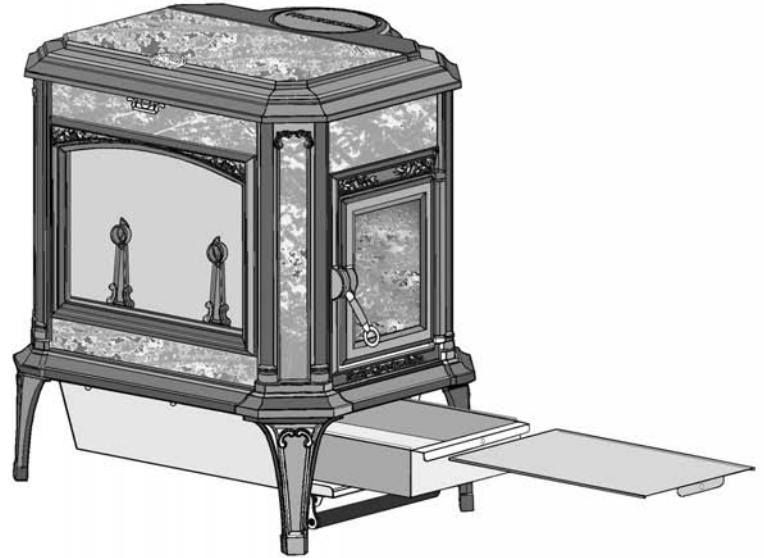

Ash Pan Holder
P-337

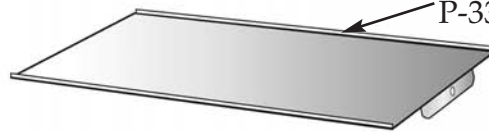

Ash Pan Cover
P-336

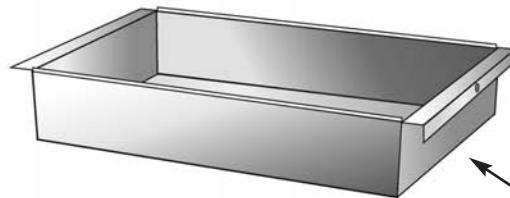

Ash Pan
P-335

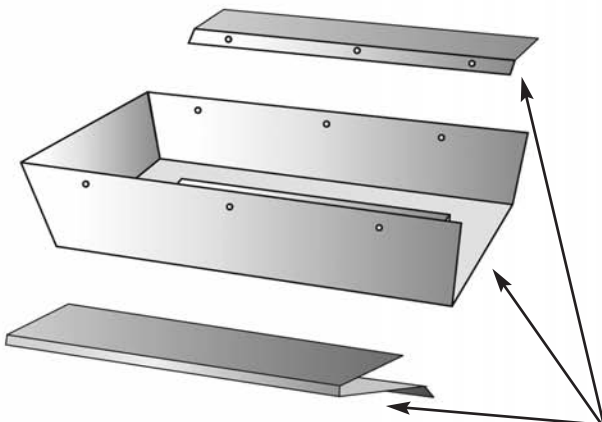

Ash box bottom
heat shield
P-341

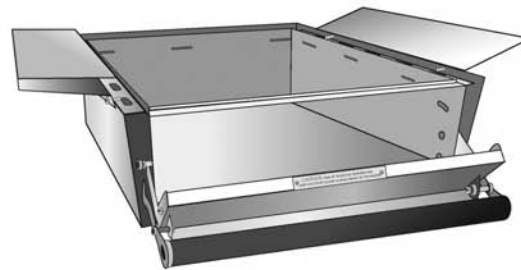

Detailed instructions and hardware are included with the ash pan kit. If you have any installation questions, please call us toll free at 1-800-866-4344